

# RMCS-2047 Nema34 Stepper Motor With Worm Gearbox 180KGCM

## Motor Specifications:

Step Angle	1.8 Degree
Configuration	4 wire bipolar stepper motor
Holding Torque	45kgcm bipolar mode
Phase current	4Amp
Resistance/phase	0.87ohm
Inductance/Phase	7.3mH
Rotor inertia	1400 gcm <sup>2</sup>
Length (L)	80mm
Shaft Dia	12.7mm
Shaft Length	32mm
Weight	2400grams

## Gearbox Specifications:

Installations for gear	Horizontal
Gear Ratio	10 : 1
Output Key Shaft Diameter	20.8mm
Output Shaft Diameter	14 mm
Ouput Key Diameter	6mm
Input Key Diameter	5mm
Category	Worm gear reducer
Gearbox weight	2.03kg

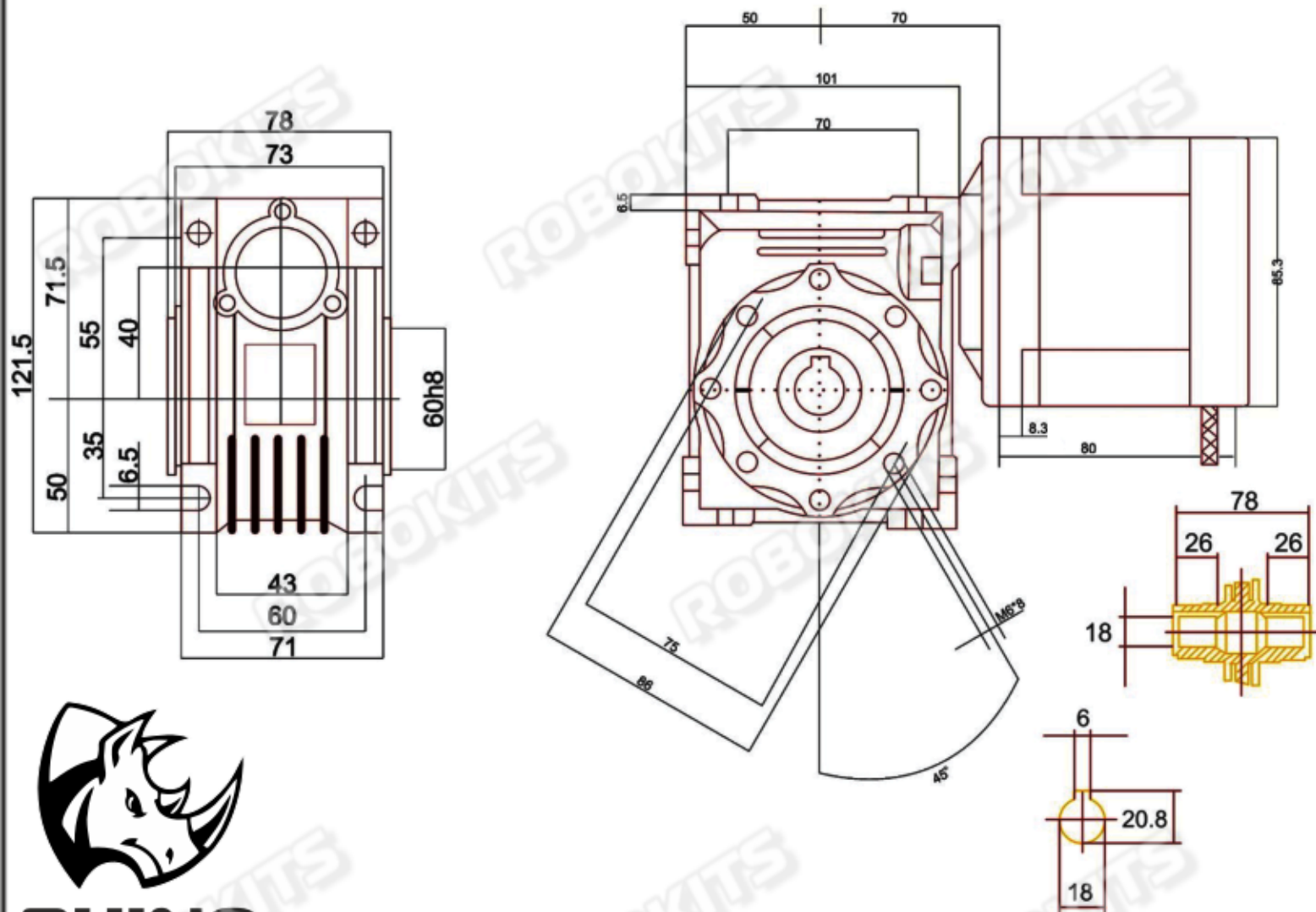

**RHINO**