

RMCS-2036 Nema34 Stepper Motor With Worm Gearbox 260KGCM

Motor Specifications:		Gearbox Specifications:	
Step Angle	1.8 Degree	Installations for gear	Horizontal
Configuration	4 wire bipolar stepper motor	Gear Ratio	15: 1
Holding Torque	45kgcm bipolar mode	Output Key Shaft Diameter	20.8mm
Phase current	4Amp	Output Shaft Diameter	14 mm
Resistance/phase	0.87ohm	Ouput Key Diameter	6mm
Inductance/Phase	7.3mH	Input Key Diameter	5mm
Rotor inertia	1400 gcm ²	Category	Worm gear reducer
Length (L)	80mm	Gearbox weight	2.03kg
Shaft Dia	12.7mm		
Shaft Length	32mm		
Weight	2400grams		

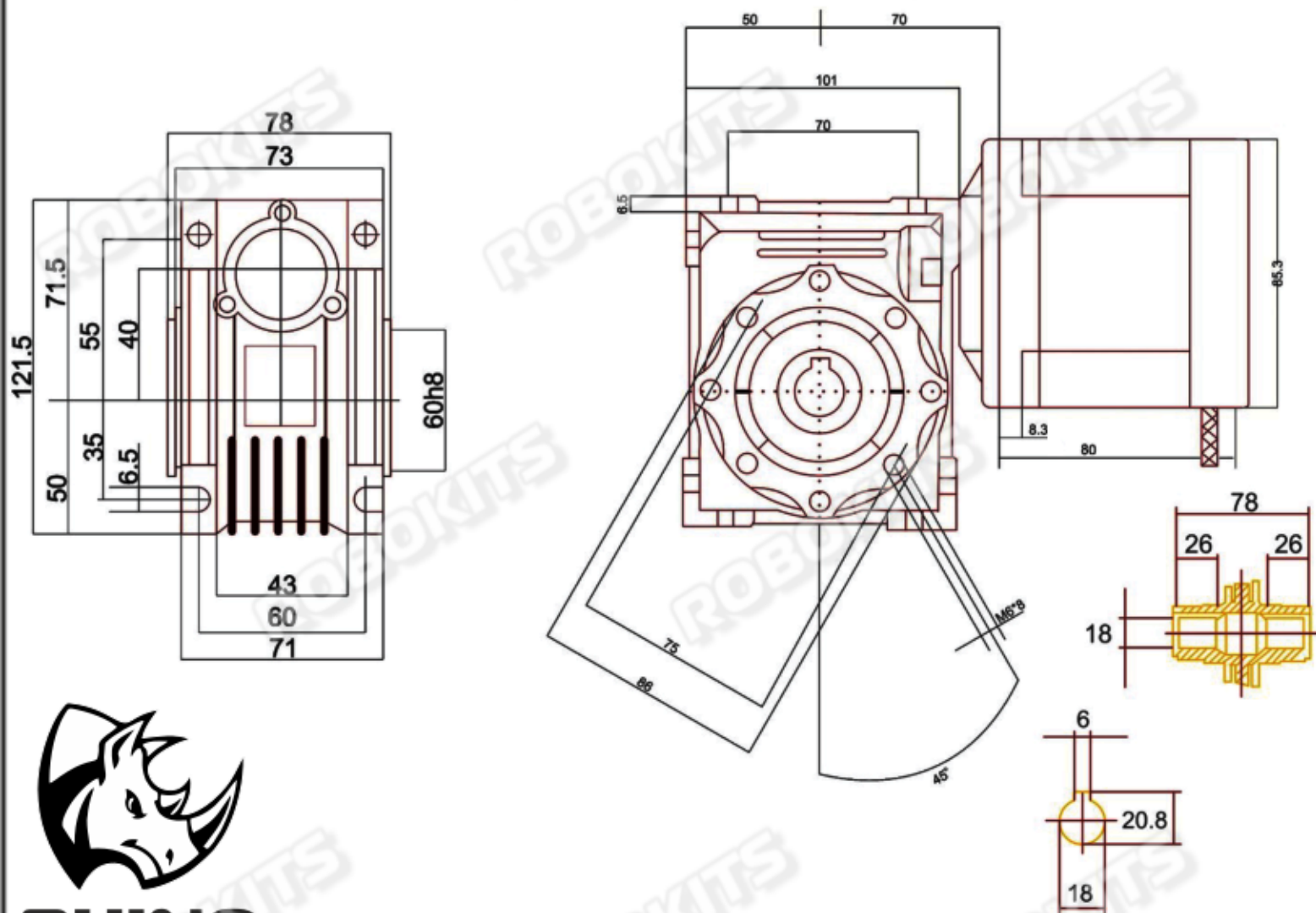

RHINO