

RMCS-2035 NEMA34 PLANETARY GEARED STEPPER MOTOR 750 KGCM

General Specifications		Electrical Specifications	
Step Angle	1.8°	Category	Planetary Gear Reducer
Configuration	4-Wire Bipolar Stepper Motor	Flange Size	86 mm (NEMA 34)
Phase Current	5 A	Efficiency	96%
Resistance per Phase	0.76 Ω	Reduction Ratio	1:15
Inductance per Phase	8.5 mH	Noise Level	< 45 dB
Rotor Inertia	2700 g·cm ²	Backlash	< 15 arc-min
Shaft Diameter	12.7 mm	Gearbox Height	53 mm
Shaft Length	32 mm	Output Shaft Dia	16 mm (Key Shaft)
Motor Weight	5.8 kg	Wiring Specifications	
		A+	Red
		A-	Green
		B+	Yellow
		B-	Blue

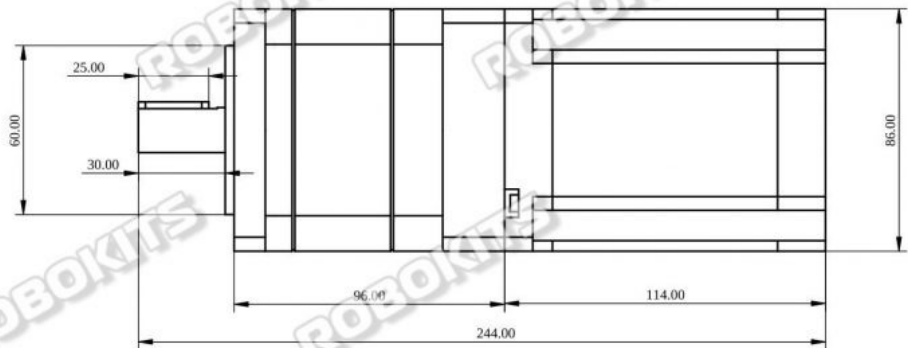
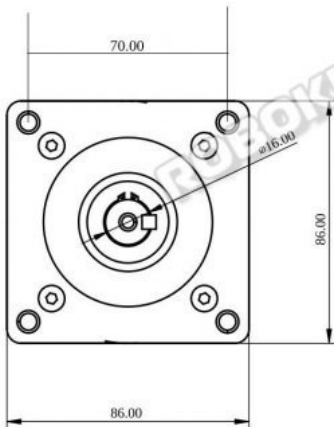

RHINO