

RMCS-2028 Nema34 Stepper Motor With Worm Gearbox 750KGCM

Motor Specifications:		Gearbox Specifications:	
Step Angle	1.8 Degree	Installations for gear	Horizontal
Configuration	4 wire bipolar stepper motor	Gear Ratio	15 : 1
Holding Torque	85kgcm bipolar mode	Output Key Shaft Diameter	20.8mm
Phase current	5Amp	Output Shaft Diameter	14 mm
Resistance/phase	0.76ohm	Ouput Key Diameter	6mm
Inductance/Phase	8.5mH	Input Key Diameter	5mm
Rotor inertia	2700 gcm ²	Category	Worm gear reducer
Length (L)	118mm	Gearbox weight	2.03kg
Shaft Dia	12.7mm		
Shaft Length	32mm		
Weight	3800 grams		

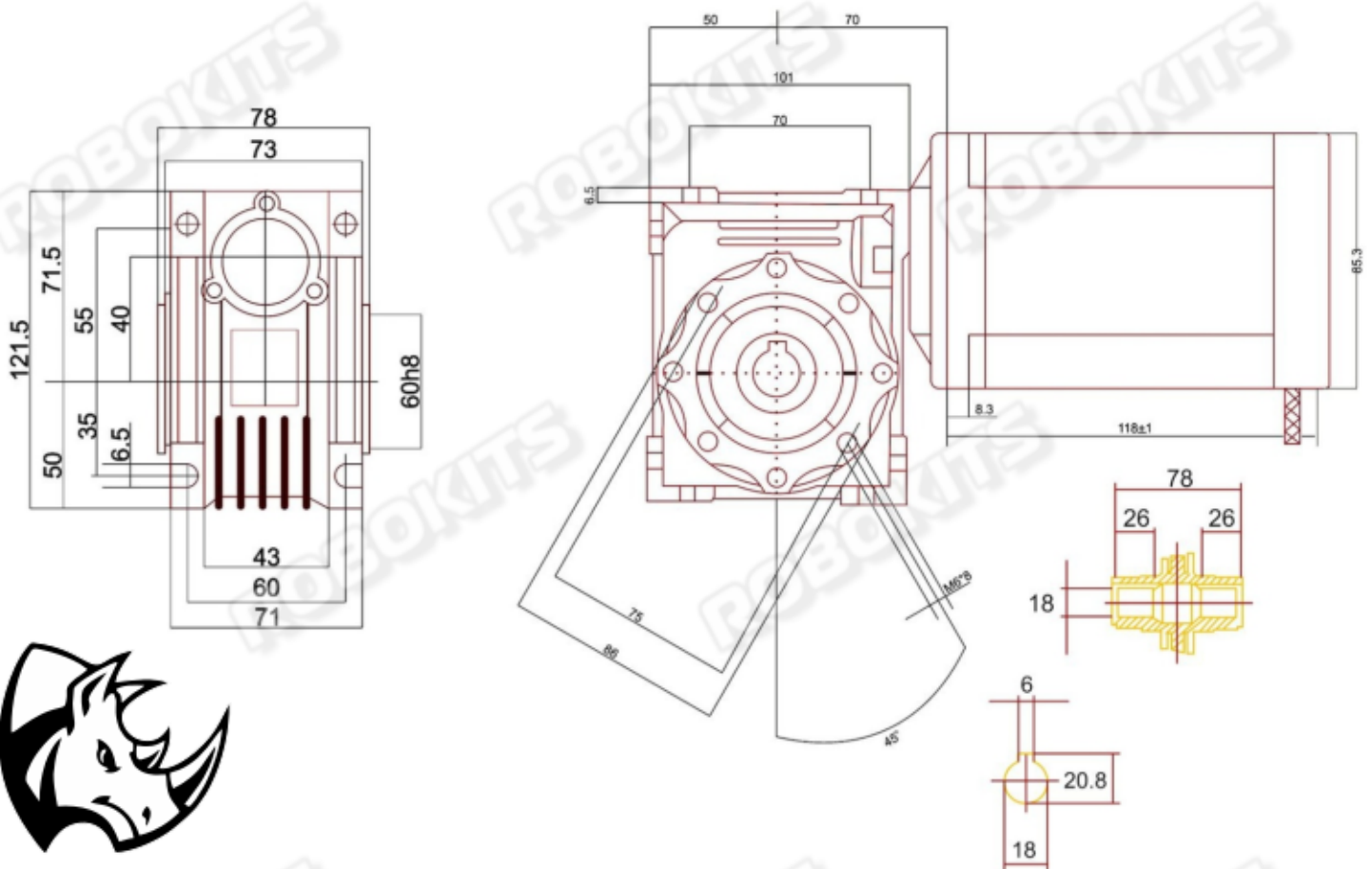

RHINO