

Model Number
RMCS-2007

**MEGA TORQUE PLANETARY DC GEARED MOTOR 250W
750RPM 18V DC**

Mechanical Drawing (Dimensions are in mm)

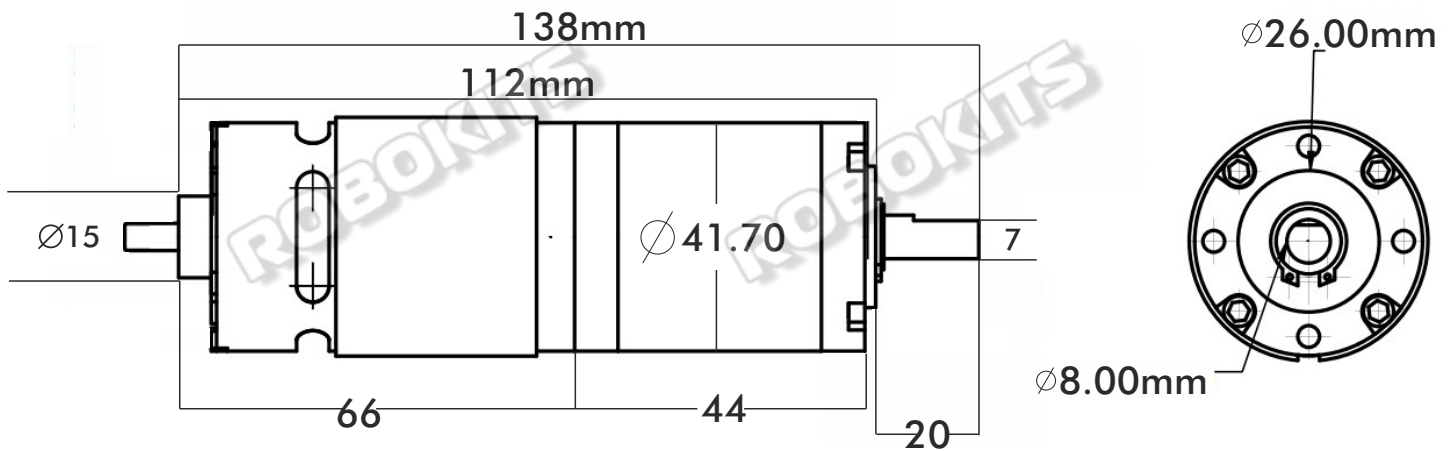

Motor Specifications

Motor Type	Industrial Grade Planetary DC Geared Motor
Operating Voltage	18V DC
Motor Speed at Output Shaft (Rpm)	780 Rpm
Stall Torque (Kgcm)	60 Kgcm
Rated Torque (Kgcm)	39 Kgcm
Gear Ratio	1:25
Weight	0.850 Kg
Gearbox Breaking Torque (Kgcm)	200 Kgcm

Base Motor Specifications

Nominal Voltage (V)	18V DC
No Load Speed (Rpm)	18100 Rmp
Rated Torque (Gcm)	1510 Gcm
No Load Current (A)	2.7 A
Load Current (A)	18.7 A (Max)



RHINO